

Safekeeper[®] SERIES

General & Special Purpose Forensic Evidence Drying Cabinets

"The World's Safest Forensic Evidence Drying Cabinet Series."



— Safekeeper[®]
FDC-006XT



Provides Environmentally Safe
Processing and Storage of Evidence

Compliant with OSHA, ANSI and
other International Standards



JUMP TO:

- Safekeeper® Series Overview (p.3)
- Features and Callouts (p.4)
- Safekeeper® Controller Options (p.5)
- Airflow and Multiplex™ Filtration Technology (p.6)
- Specifications (p.8)
- Options and Accessories (p.12)



APPLICATIONS

- State and Federal Crime Laboratories
- Medical Examiners and Coroners
- Law Enforcement Agencies
- Hospital Emergency Rooms
- Drug Agencies



INTRODUCTION

Safekeeper® series forensic evidence drying cabinets are designed to store, dry or otherwise process forensic evidence in the controlled environment of a tamper resistant compartment to maintain the chain of custody.

The industry leading Multiplex™ filtration system, combined with professional design and construction offer convenience and protect the safety of personnel during use, maintenance and decontamination of the cabinets.

Safekeeper^{series}
General Purpose Series Drying Cabinets

- General purpose Safekeeper cabinets are available in bench/desktop and floor-standing models. Select models are available with two, three or four independent drying chambers, each with its own filtration and control system.
- Most models are designed and configured for mobile use in uncontrolled environments.
- Safekeeper FDC-002, left. Shown with timed UV decontamination system.

Special Purpose Series Drying Cabinets

- The Drugkeeper series is designed for safe storage of confiscated hazardous chemicals and illegal drugs.
- The Safeswab horizontal airflow cabinet is useful for protecting biological evidence collected on swabs from external contaminants, and personnel in the working environment.
- The Transporter is an "on-site" fabric chamber developed for transporting evidence from the field to the lab.
- Safeswab FDC-001, left



**DUCTLESS TECHNOLOGY:
The Eco-friendly Choice**

Advanced carbon filtration technology offers a safe, high performance alternative to ducted cabinets for a broad range of law enforcement applications.

- **Environmental Benefits.** Air Science Safekeeper forensic evidence drying cabinets isolate and trap biological and chemical vapors to prevent operator exposure, prevent cross contamination, and eliminate ecological impact through release into the environment.
- **Versatile.** Each filtration system is designed for specific forensic applications using our exclusive Multiplex filtration technology.
- **Easy to Install.** Safekeeper drying cabinets are self-contained; venting to the outside is optional. Downflow and standard units are portable and may be moved from one location to another without filter changes and with minimal downtime. Set-up, operation and filter maintenance are straightforward.
- **Energy Efficient.** Because filtered air is returned to the room, no demands are required of the facility HVAC capacity for make-up air.
- **Cost Effective.** Facility ductwork, HVAC and construction costs are eliminated... > p3



This Product Exceeds OSHA, ANSI and Other International Standards.

- **Safe to Use.** Cabinet airflow and face velocity protect users from incidental exposures to fumes, odors or bloodborne pathogens.
- **Self Testing.** (select models) Electronic airflow monitoring assures continuous safety. An electronic gas sensor monitors carbon filter performance.

MANAGING FORENSIC EVIDENCE:

Because cross-contamination can occur when drying blood-stained or wet evidence on examination tables, on a floor, in a jail cell, shower stall, closet, evidence room or in the trunk of a patrol car, loss of trace evidence and lack of evidence security can compromise a case.

The Air Science Safekeeper series of drying and storage cabinets provide a secure, tamper-resistant area for drying and storing clothing, bed sheets, blankets, towels or other items collected from homicide and sexual assault cases. Safekeeper cabinets are constructed of polypropylene that does not absorb liquids, is easily

cleaned with household detergents, and can be sprayed with a 10% bleach solution to eliminate bloodborne pathogens and DNA.

Cross-contamination between items of evidence dried in Safekeeper cabinets is eliminated. The cabinet floor may be lined with a kraft paper sheet or an optional evidence collection

tray to catch trace evidence such as hair or fibers that may fall off the substrate. Optional self-locking evidence security tags provide tamper-resistant "locks" to keep contents secure during drying, maintaining and documenting the chain of custody and reducing defense challenges to evidence handling.

The Air Science Multiplex filtration system prevents cross-contamination and fully protects the operator from the hazards associated with the evidence. It also provides the cleanest air available in the industry. Because there is no ANSI standard for forensic drying cabinets, Air Science

Safekeeper products are designed to meet ANSI ductless fume hood specifications. The Air Science carbon filter provides superior efficiency with an optional safety filter to bring the cabinet into full ANSI compliance.

MULTIPLEX™ FILTRATION GENERAL PURPOSE SERIES

SPECIAL PURPOSE SERIES



Product Map	Safekeeper™							Drugkeeper		Safeswab		Transporter	
	Floor Mounted (all sizes)				Benchtop	Downflow		Floor Mounted		Benchtop	Desktop		Mobile
	Single	Duplex	Tri	Quad	Single	Single	Duplex	Single	Duplex	Single	Single	Single	Single
Nominal Width (inches)	30, 36, 39, 48, 60, 72, 96	48, 60, 72, 96	72	72	24, 30	36, 48, 60	36, 48, 60	34	64	34	18	7	28
Airflow													N/A
DNA Decontamination	optional	optional	optional	optional	optional	optional	optional	optional	optional	optional	optional	optional	N/A

Multiplex™ Filtration
Door Filter, Pre-Evidence

Electrostatic	standard	standard	standard	standard	standard	standard	standard	standard	standard	standard	standard	standard	standard	standard
HEPA / ULPA	optional	optional	optional	optional	optional	optional	optional	optional	optional	optional	optional	optional	optional	optional

Main Filters, Post-Evidence

First	electrostatic	electrostatic	electrostatic	electrostatic	electrostatic	electrostatic	electrostatic	electrostatic	electrostatic	electrostatic	HEPA / ULPA	HEPA / ULPA	HEPA / ULPA
Second, Biological	HEPA / ULPA	HEPA / ULPA	HEPA / ULPA	HEPA / ULPA	HEPA / ULPA	HEPA / ULPA	HEPA / ULPA	HEPA / ULPA	HEPA / ULPA	HEPA / ULPA	--	--	--
Third	carbon	carbon	carbon	carbon	carbon	carbon	carbon	carbon	carbon	carbon	--	--	--

Exhaust, Back-up, Biological or Emergency Filtration

Carbon or HEPA / ULPA	optional	optional	optional	optional	optional	--	--	optional	optional	optional	--	--	--
-----------------------	----------	----------	----------	----------	----------	----	----	----------	----------	----------	----	----	----



Safekeeper FDC-007D duplex model, shown open.

SAFEKEEPER® PRODUCT FEATURES:

A. Filter I.D. Window: When specified, the front cover has a window that reveals the installed filter part number and installation date for convenience and to encourage timely filter replacement.

B. Filter Door Key: Filter access keys prevent unauthorized removal or accidental exposure to dirty filters.

C. Control Panel: Electronic controls and displays include switches for the blower and lights, an electronic hour counter and low airflow alarm, all located on a convenient front surface panel.

D. Hour Counter: Assists in tracking evidence drying time.

E. Internal Manual Speed Controller: Authorized personnel may set the centrifugal fan motor speed as desired.

F. Airflow Alarm: A continuous air velocity monitoring system alerts the operator upon unacceptable values.

G. Dynamic Filtration Chamber: The dynamic filter chamber prevents any possible leakage of contaminated air by pressurizing the fan plenum (positive air) and depressuring the filter compartment (negative air).

H. Outside Sidewall Hose: Connects to external water supply, located to avoid tripping hazard.

I. Hanging Rod: All General Purpose and Downflow models have a removable stainless steel hanging rod with anti-slide cover.

J. Drain: Central 1.5" bottom drain with anti-siphon trap and strainer to capture contaminants in waste water stream.

K. Push-Pull™ Shelving: All General Purpose models have three perforated polypropylene Push-Pull™ shelves with drain channel that can be installed and removed with one hand and may be stored within or outside the cabinet; two included with Downflow unit.

L. Color: The cabinet is white with blue doors.

M. Drain Valve: Manual open and close drain valve.

N. Electrostatic Pre-Filter: All pre-filters (doors and main) are changed quickly without tools and are of a standard size for simple stocking and ordering. Optional HEPA filter available.

O. Doors: Blue metal framed tempered glass doors with key lock, tamper proof seal, provide improved security, stability, and ease of cleaning.

P. Built-in Containment Compartment: Adheres to Occupational Safety and Health Administration (OSHA) standards 29 CFR 1910.1030 regarding bloodborne pathogens.

OTHER FEATURES:

Standards Compliant: Performance specifications and construction meet or exceed OSHA, ANSI and relevant international standards to assure operator safety.

Construction: The cabinet features white polypropylene and epoxy coated steel construction; tempered glass doors; and 110V, 60Hz single phase electrical supply (other voltages are available on request).

Optional UV Lamp: Activated ultraviolet light provides secondary disinfection of the interior between cases to prevent cross contamination, ensuring integrity of the samples for DNA testing.

**SAFEKEEPER®
STANDARD SERIES
FEATURES & BENEFITS**

General Purpose Safekeeper Forensic Evidence Drying Cabinets.

- Upflow airflow geometry.
- 120-180 fpm face velocity (Triplex and Quad models are 100 fpm).
- Activated carbon main filter formulated for General Purpose and Downflow forensic evidence drying captures putrid organic odors as well as other fumes that may be available (i.e. alcohol, solvents, gasoline, etc.).
- Leveling feet standard on XT models; caster wheels standard on all other general purpose models.
- Three Push-Pull™ shelves per compartment.
- Minimal site preparation required.



High strength polypropylene shelves are perforated to permit maximum airflow throughout. Shelves are chemically resistant, easily removable and easy to clean.



The standard **Advanced** control panel includes an on/off switch, low airflow alarm and hour meter to aid in determining available filter life.



An electronic **Filter Saturation Alarm (FSA)** is available with the **Advanced** control panel. In addition to all the features of the **Advanced** control panel the **FSA** adds an electronic gas sensor and emits audio and visual alerts when the main filter needs to be changed.

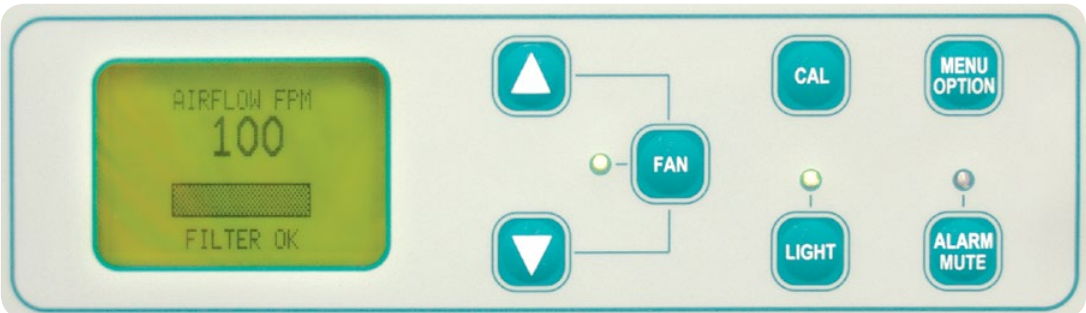

Monitair® Control Panel monitors cabinet operating parameters, airflow, containment, and filter condition; emits audio and visual alerts if conditions become unsafe.

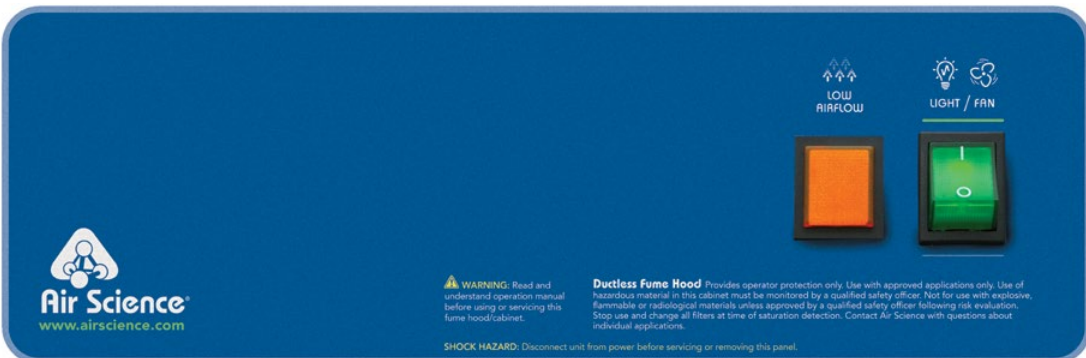

Standard on Drugkeeper™ the **Basic** control panel. Includes on/off switch and low airflow alarm.

THE AIR SCIENCE PERFORMANCE ADVANTAGE

Each Air Science Safekeeper forensic evidence drying cabinet includes features expressed through sound design and certified quality construction. Options and accessories add functional performance to meet specific applications.

Professional Quality.

Air Science Safekeeper forensic evidence drying cabinets comply with current technical and safety regulations.

Multiplex Filtration.

The Air Science Multiplex Filter offers high performance and safety.

Industrial Components.

The cabinet frame and work surfaces are durable and chemically resistant.

Reliability.

Internal systems are isolated from fumes, extending product life.



The main filter gasket evenly seals the filter face to prevent bypass air leakage. Safekeeper and Drugkeeper filters are formulated to capture fumes, odors and chemical vapors.

AIR SCIENCE SAFEKEEPER® SERIES ADVANTAGES

Safekeeper forensic evidence drying cabinets provide cost-effective storage and containment for forensic evidence as it is dried by a constant flow of air. Air Science ductless technology removes airborne pathogens, particulates, fumes, and odors emitted by the contents.

Safekeeper forensic evidence drying cabinets offer these advantages:

- Elimination of putrid odors and chemical fumes using eco-friendly ductless technology carbon filtration.
- Effective protection to personnel from particulate hazards.
- ANSI Z9.5 compliance with optional safety back-up filters on selected models.
- Controlled airflow to dry items of evidence in the cabinet.
- Lockable doors with tamper-proof seals for security.
- Broad range of sizes for diverse needs.
- Selected models available with versatile two, three and four independent drying chambers.
- Easily cleaned to protect items of evidence from cross-contamination.
- Safe and easy to change filters
- Compliant with OSHA/ANSI regulations
- Push-pull™ shelving, hanging rods and lockable front doors facilitate application of cabinets to many situations.
- Standard height and Downflow models are designed to be moved around a building through standard doorways and elevators. *Extra tall units are intended to remain stationary in one room.*



AIR SCIENCE MULTIPLEX FILTRATION TECHNOLOGY

Multiplex airflow and filtration elements for general purpose series drying cabinets.

- Electrostatic pre-evidence filter with 99.5% efficiency down to 0.5 microns protects evidence from cross-contamination by air drawn into the unit. It can be changed without tools. Optional HEPA/ULPA filter available.
- Additional electrostatic pre-filter (duplicate of the pre-evidence filter) protects and extends the life of main and optional exhaust filters and can be changed without tools while unit is running to prevent operator exposure to captured contaminants.
- HEPA/ULPA main filter captures biological and other particles larger than 0.3 microns (HEPA) or 0.12 microns (ULPA).
- Activated carbon main filter, selected for General Purpose and downflow forensic evidence drying; filter captures putrid organic odors as well as other fumes that may be present, (e.g., alcohol, solvents, gasoline, etc.).
- Security key to filter access door.
- The carbon main filter selected for Drugkeeper models captures specific vapors generated by typical substances found at methamphetamine labs.
- Filter clamping mechanism allows removal of main filter(s) directly to disposal bag with track and wheel system.
- Filter gasket evenly seals filter faces to prevent bypass air leakage.
- Inter-filter test port allows air sampling for manual testing of filter performance.
- Filter identification window shows the installed filter part number and installation date for convenience and to encourage timely filter replacement.
- Optional HEPA/ULPA exhaust filter (complies with ANSI Z9.5 when fitted).
- Optional exhaust collar.
- High velocity sparkless and brushless centrifugal fan.
- Dynamic filtration chamber prevents any possible leakage of contaminated air by pressurizing the fan plenum (positive air) and depressurizing the filter compartment (negative air).

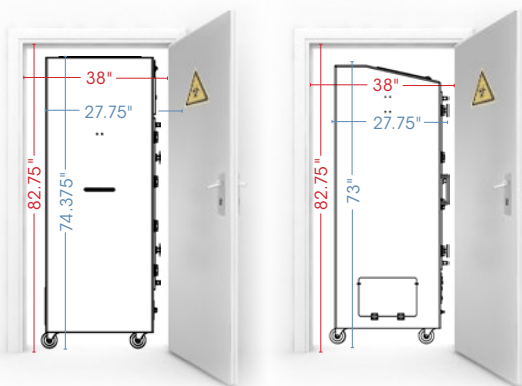

Standard Units

Downflow Units

SAFEKEEPER® MOBILITY

Standard height and Downflow models are designed to be moved around a building through standard doorways and elevators.

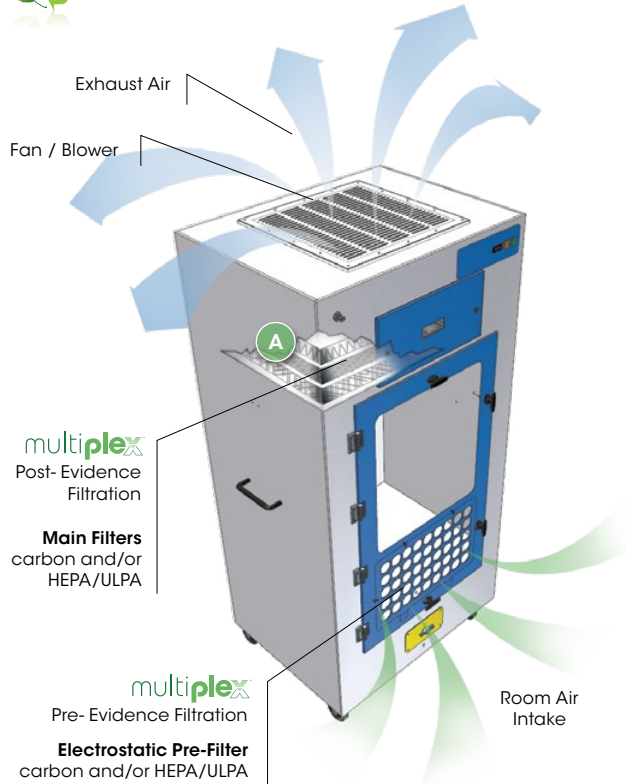
**AIRFLOW PATTERN:
SAFEKEEPER UPFLOW CABINET**

Safekeeper® FDC-006, shown with 5-Stage Multiplex™ Filtration System.

A. The main filter is easy to replace, no tools required. The filter clamps tightly against the filter gasket to prevent filter bypass and maintain filter integrity.

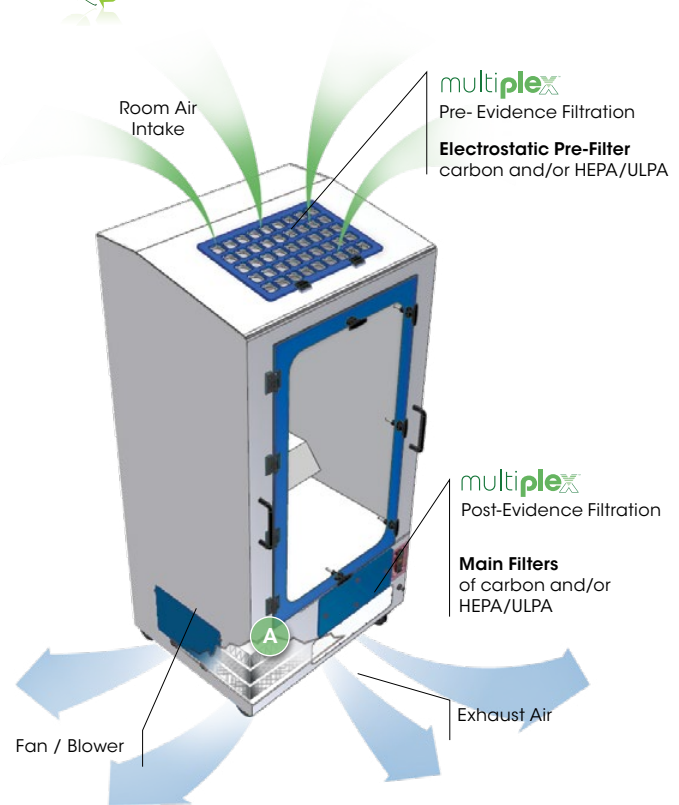
**AIRFLOW PATTERN:
SAFEKEEPER DOWNFLOW CABINET**

Safekeeper® FDC-006XL, shown with Multiplex™ Filtration System.

A. The main filter is easy to replace, no tools required. The filter clamps tightly against the filter gasket to prevent filter bypass and maintain filter integrity.

**DECONTAMINATION
AND WASTE WATER
REMOVAL FEATURES:
General Purpose
Units, including
Downflow Models.**

- Outside sidewall hose connection to external water supply, located to avoid tripping hazard.
- Internal wash down spray hose for decontamination and cleaning.
- Central 1.5" bottom drain with anti-siphon trap.
- Strainer to capture contaminants in waste water stream.
- Optional OSHA Biohazard labeled waste water container for use when drain is not available.
- Electric waste water pump with foot activated switch to pump to remote drains (not available on Downflow).
- Optional locking waste water compartment with cover to prevent spillage during transport (standard on Downflow models). Included OSHA Biohazard labeled waste water tank.
- Optional on-board clean water tank with electric pump.

- Optional automatic wash down system with sprinkler heads to wash interior of cabinet. Includes cleaning agent injection and mixing tank.

SITE PREPARATION

The Safekeeper Drying Cabinets with floor drain are designed to eliminate the need for hard plumbing, drain traps or hard wiring. Downflow and standard models are uniquely sized to pass through standard doorways.

Water Supply

- Hose location is exterior, right side, with 8' hose provided.

- Hose is configured for standard water faucet connection with female fitting.
- Standard tap water supply pressure recommended; greater pressures require an optional water regulator.

Drain

- A hard drain and trap is not required.
- The interior drain is flush with the chamber floor and employs gravity and an integrated powered assist pump.
- Drain hose routes to standard sink, floor drain or container.

Electrical

- Line cord provided with standard molded plug, NEMA 4-14P for quick connection to standard wall outlet, NEMA 5-15R.
- A separate breaker is recommended.
- Line cord location is at cabinet top.

Exhaust

- Ductless filter output cabinet top.
- Optional 8" collar available with butterfly valve for external ducting.



IMPORTANT: PROTECT SKIN / EYES FROM EXPOSURE WHEN UV LAMP IS ON.

60
30
10
OFF
HOLD
60
50
40
30

UV TIMER

UV Controller
OPERATING INSTRUCTIONS:
UV lamps can be turned on only when door, sash, or front cover is closed. To activate UV, turn knob to desired setting. UV will deactivate automatically at the end of the cycle.

WARNING: Read and understand operation manual before using.

Air Science
www.airscience.com

UV timer permits timed or hold operation of UV decontamination lamp feature.



DNA Decontamination UV Lamp System (optional) provides secondary disinfection of the interior between cases to prevent cross-contamination, ensuring integrity of samples for DNA testing.



Safekeeper^{SERIES}

General Purpose : Benchtop

Safekeeper Benchtop models are sized to fit on a standard lab bench. The 30" tall model fits on a 24" deep bench, and the 48" tall model fits on a 30" deep lab bench.

Safekeeper FDC-002

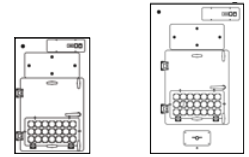

FDC-002M

FDC-002

MODEL	DIMENSIONS			WEIGHT (lbs/Kg)	
	Nominal Width	External (W x D x H)	Shipping (W x D x H)	Net	Ship
Desktop Models					
FDC-002M	24" 610 mm	24" x 24" x 30" 610 x 610 x 762 mm	40" x 40" x 40" 1016 x 1016 x 1016 mm	68 / 31	118 / 54
FDC-002	30" 726 mm	30" x 27.75" x 48" 762 x 705 x 1219 mm	40" x 40" x 60" 1016 x 1016 x 1524 mm	110 / 50	160 / 73



Safekeeper^{SERIES}

General Purpose : Downflow

Safekeeper Downflow Forensic Evidence Drying Cabinets, designed for use in a garage or parking area with dirty/sandy floors, feature activated carbon main filter formulated to capture putrid organic odors as well as other fumes that may be available (e.g., alcohol, solvents, gasoline, etc.).

Safekeeper FDC-006GL



FDC-006GL

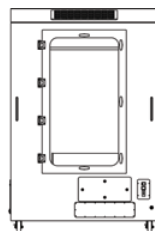

FDC-007GL

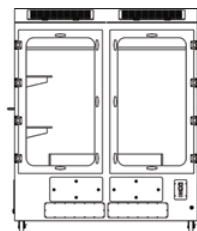

FDC-008GL

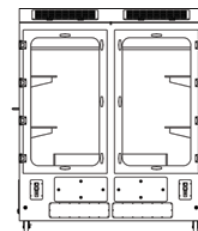

FDC-008DGL



Downflow
(side view)

Standard Downflow Models

FDC-006GL	36" 914 mm	36" x 28" x 73" 914 x 711 x 1854 mm	40" x 40" x 88" 1016 x 1016 x 2235 mm	229 / 104	273 / 124
FDC-007GL	48" 1219 mm	48" x 28" x 73" 1219 x 711 x 1854 mm	58" x 40" x 88" 1473 x 1016 x 2235 mm	403 / 183	445 / 202
FDC-008GL	60" 1524 mm	60" x 28" x 73" 1524 x 711 x 1854 mm	65" x 40" x 88" 1651 x 1016 x 2235 mm	471 / 214	520 / 236

Duplex Model (2 chambers)

FDC-008DGL	60" 1524 mm	60" x 28" x 73" 1524 x 711 x 1854 mm	65" x 40" x 88" 1651 x 1016 x 2235 mm	485 / 220	530 / 241
------------	----------------	---	--	-----------	-----------

This Product Exceeds OSHA, ANSI and Other International Standards.

**SAFEKEEPER®
SERIES SHELVING
CONFIGURATIONS**

Following are a comparison of shelf and hanging rod configurations for various Safekeeper cabinet models.

- All General Purpose models have three perforated polypropylene Push-Pull™ shelves with drain channel that can be installed and removed with one hand and may be stored within or outside the cabinet; two included with Downflow unit.
- All General Purpose and Downflow models have a removable stainless steel hanging rod with anti-slide cover.
- Drugkeeper models include open wire adjustable shelves.
- Optional evidence collection and drying trays with handles that fit in the bottom of the cabinet are available on all units.



Safekeeper SERIES

General Purpose : Single Chamber

Single chamber evidence drying cabinets are available in six exterior widths (from 30" to 96") and two heights (74.375" and 82.25"). Each model includes a single control system and single or dual filter/blower systems depending on size.

Standard height cabinets are designed to pass through standard doorways on casters for maximum mobility. **Tall** units offer a greater drying height and are typically located in a fixed position and are not usually moved from one location to another.

Safekeeper FDC-006XT; shown with optional UV decontamination lamp.

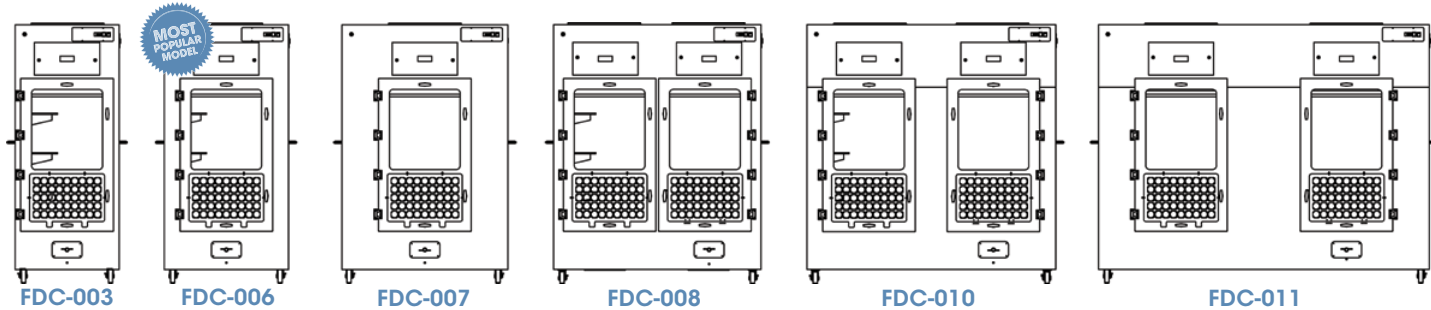
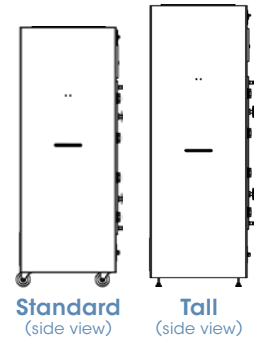

MODEL	DIMENSIONS			WEIGHT	
	Nominal Width	External (W x D x H)	Shipping (W x D x H)	Net (lbs/Kg)	Ship (lbs/Kg)

Standard Height Models (1 chamber)

FDC-003	30" 762 mm	30" x 27.75" x 74.375" 762 x 705 x 1890 mm	40" x 40" x 89" 1016 x 1016 x 2260 mm	213 / 97	245 / 111
FDC-006	36" 914 mm	36" x 27.75" x 74.375" 914 x 705 x 1890 mm	40" x 40" x 89" 1016 x 1016 x 2260 mm	229 / 104	273 / 124
FDC-006XL	39" 991 mm	39" x 27.75" x 74.375" 991 x 705 x 1890 mm	45" x 40" x 89" 1143 x 1016 x 2260 mm	258 / 117	302 / 137
FDC-007	48" 1219 mm	48" x 27.75" x 74.375" 1219 x 705 x 1890 mm	58" x 40" x 89" 1473 x 1016 x 2260 mm	403 / 183	445 / 202
FDC-008	60" 1524 mm	60" x 27.75" x 74.375" 1524 x 705 x 1890 mm	65" x 40" x 89" 1651 x 1016 x 2260 mm	471 / 214	520 / 236
FDC-010	72" 1829 mm	72" x 27.75" x 74.375" 1829 x 705 x 1890 mm	80" x 40" x 89" 2032 x 1016 x 2260 mm	586 / 266	609 / 276
FDC-011	96" 2438 mm	96" x 27.75" x 74.375" 2438 x 705 x 1890 mm	106" x 40" x 89" 2692 x 1016 x 2260 mm	670 / 304	715 / 324

MODEL	DIMENSIONS			WEIGHT	
	Nominal Width	External (W x D x H)	Shipping (W x D x H)	Net (lbs/Kg)	Ship (lbs/Kg)

Tall Models (1 chamber)

FDC-003XT	30" 762 mm	30" x 27.75" x 82.25" 762 x 705 x 2090 mm	40" x 40" x 89" 1016 x 1016 x 2261 mm	213 / 97	245 / 111
FDC-006XT	36" 914 mm	36" x 27.75" x 82.25" 914 x 705 x 2090 mm	40" x 40" x 89" 1016 x 1016 x 2260 mm	229 / 104	273 / 124
FDC-006XL-XT	39" 991 mm	39" x 27.75" x 82.25" 991 x 705 x 2090 mm	45" x 40" x 89" 1143 x 1016 x 2260 mm	258 / 117	302 / 137
FDC-007XT	48" 1219 mm	48" x 27.75" x 82.25" 1219 x 705 x 2090 mm	58" x 40" x 89" 1473 x 1016 x 2260 mm	403 / 183	445 / 202
FDC-008XT	60" 1524 mm	60" x 27.75" x 82.25" 1524 x 705 x 2090 mm	65" x 40" x 89" 1651 x 1016 x 2260 mm	471 / 214	520 / 236
FDC-010XT	72" 1829 mm	72" x 27.75" x 82.25" 1829 x 705 x 2090 mm	80" x 40" x 89" 2032 x 1016 x 2260 mm	586 / 266	609 / 276
FDC-011XT	96" 2438 mm	96" x 27.75" x 82.25" 2438 x 705 x 2090 mm	106" x 40" x 89" 2692 x 1016 x 2260 mm	670 / 304	715 / 324

Safekeeper[®] General & Special Purpose Forensic Evidence Drying Cabinets

SAFEKEEPER[®] DOWNFLOW SERIES FEATURES & BENEFITS

- Downflow airflow geometry.
- Monitair[®] control system. (optional)
- Caster wheels standard.
- Two Push-Pull[™] shelves per compartment.



Air Science Safekeepers use energy-efficient ebmpapst[™] brand centrifugal blowers for long life and dependable performance.



A convenient spray hose simplifies cleaning of the interior chamber. A standard water supply fitting is used to connect the cabinet to a common utility faucet.



Safekeeper[®] General Purpose : Multi-Chamber



Multiple chamber evidence drying cabinets feature independently filtered and controlled chambers within a single cabinet. Choose from two, three or four chamber models.

TRI and QUAD cabinets feature independent chambers and filtration systems to permit simultaneous but separated processing. These cabinets are available in tall configurations only.

Left to right; Safekeeper FDC-010D, Safekeeper FDC-010-QUAD and Safekeeper FDC-010-TRI

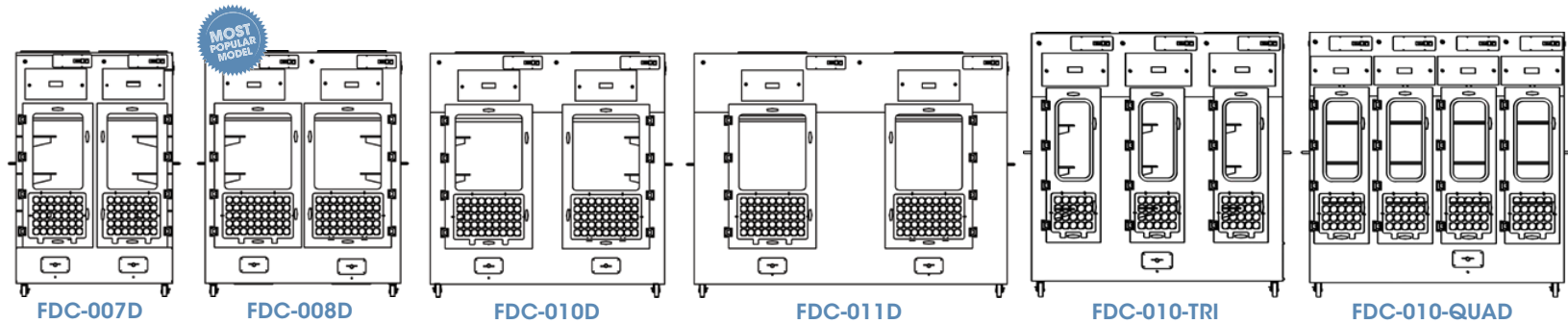
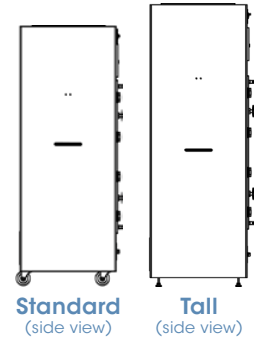

MODEL	DIMENSIONS			WEIGHT	
	Nominal Width	External (W x D x H)	Shipping (W x D x H)	Net (lbs/Kg)	Ship (lbs/Kg)

Standard Height Duplex Models (2 chambers)					
FDC-007D	48" 1219 mm	48" x 27.75" x 74.375" 1219 x 705 x 1890 mm	58" x 40" x 89" 1473 x 1016 x 2260 mm	451 / 205	502 / 228
FDC-008D	60" 1524 mm	60" x 27.75" x 74.375" 1524 x 705 x 1890 mm	65" x 40" x 89" 1651 x 1016 x 2260 mm	485 / 220	530 / 241
FDC-010D	72" 1829 mm	72" x 27.75" x 74.375" 1829 x 705 x 1890 mm	80" x 40" x 89" 2032 x 1016 x 2260 mm	601 / 273	623 / 283
FDC-011D	96" 2438 mm	96" x 27.75" x 74.375" 2438 x 705 x 1890 mm	106" x 40" x 89" 2692 x 1016 x 2260 mm	715 / 324	760 / 345

MODEL	DIMENSIONS			WEIGHT	
	Nominal Width	External (W x D x H)	Shipping (W x D x H)	Net (lbs/Kg)	Ship (lbs/Kg)

Tall Duplex Models (2 chambers)					
FDC-007DXT	48" 1219 mm	48" x 27.75" x 82.25" 1219 x 705 x 2090 mm	58" x 40" x 89" 1473 x 1016 x 2260 mm	451 / 205	502 / 228
FDC-008DXT	60" 1524 mm	60" x 27.75" x 82.25" 1524 x 705 x 2090 mm	65" x 40" x 89" 1651 x 1016 x 2260 mm	485 / 220	530 / 241
FDC-010DXT	72" 1829 mm	72" x 27.75" x 82.25" 1829 x 705 x 2090 mm	80" x 40" x 89" 2032 x 1016 x 2260 mm	601 / 273	623 / 283
FDC-011DXT	96" 2438 mm	96" x 27.75" x 82.25" 2438 x 705 x 2090 mm	106" x 40" x 89" 2692 x 1016 x 2260 mm	715 / 324	760 / 345

Triplex Models (3 chambers)					
FDC-010-TRI	72" 1829 mm	72" x 27.75" x 82.25" 1829 x 705 x 2090 mm	80" x 40" x 89" 2032 x 1016 x 2260 mm	689 / 313	739 / 335

Quad Models (4 chambers)					
FDC-010-QUAD	72" 1829 mm	72" x 27.75" x 82.25" 1829 x 705 x 2090 mm	80" x 40" x 89" 2032 x 1016 x 2260 mm	723 / 328	773 / 351

DRUGKEEPER™ STORAGE CABINETS FEATURES & BENEFITS

- Reduces exposure to carcinogenic chemicals involved in illegal drug production and processing.
- With HEPA/ULPA filter, eliminates exposure to toxic mold (aflatoxins) on marijuana plants and permits wet plants and leaves to be dried quickly.
- Upflow airflow geometry operates at 120-180 fpm face velocity to exchange air through activated carbon main filter.
- Filter is formulated to capture specific vapors generated by typical chemicals collected at methamphetamine labs.
- Windowless doors recommended if located in viewable areas.



Drugkeeper™
Special Purpose : Storage Cabinets



Drugkeeper Storage Cabinets are useful for short-term storage of hazardous chemicals and other substances typically associated with drug investigations.

Minimizes health and environmental risks associated with handling chemical vapors and residues, VOCs and other materials associated with methamphetamine production.

Drugkeeper 64T

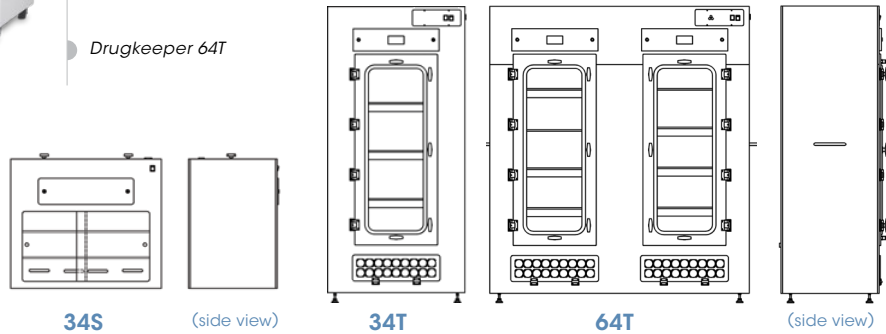

MODEL	Shelves		External (W x D x H)	Shipping (W x D x H)	WEIGHT (lbs/Kg)	
	Net	Ship				
Drugkeeper™ Models						
34S	4		34" x 20" x 29" 864 x 508 x 740 mm	40" x 40" x 40" 1016 x 1016 x 1016 mm	115 / 55	170 / 80
34T	5		34" x 24" x 71" 864 x 610 x 1800 mm	40" x 40" x 87" 1016 x 1016 x 2210 mm	229 / 104	273 / 124
64T	10		64" x 24" x 71" 1626 x 610 x 1800 mm	80" x 40" x 87" 2032 x 1016 x 2210 mm	586 / 266	609 / 276



Drugkeeper shelves are open wire, easily adjustable and removable for cleaning. Access to the pre-filter is from the interior.

SAFESWAB™ & SAFESWAB MINI™ FEATURES & BENEFITS

- Horizontal airflow geometry.
- Swab holder included.



Safeswab
Special Purpose : Swab Dryer



With HEPA main filter formulated to contain any particulates or biological material that might be present on swabs, Safeswab is used to safely dry evidence swabs while protecting them from cross-contamination.

Safeswab FDC-001 and Safeswab Mini FDC-001M

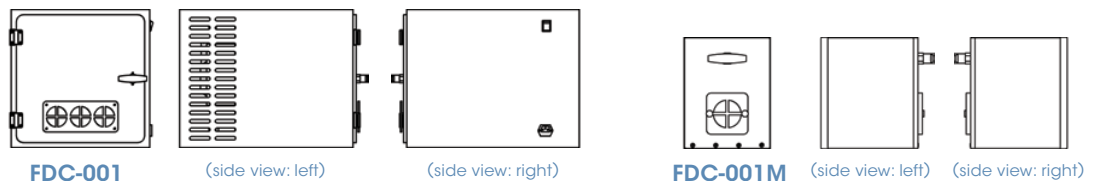

MODEL	Racks		External (W x D x H)	Shipping (W x D x H)	WEIGHT (lbs/Kg)	
	Swab Capacity	Net			Ship	
Safeswab™ Models						
FDC-001	2	30	16" x 20" x 16" 406 x 508 x 406 mm	24" x 24" x 24" 610 x 610 x 610 mm	18 / 8.2	25 / 11.4
FDC-001M	1	15	7.5" x 8" x 9.5" 191 x 204 x 242 mm	12" x 12" x 12" 305 x 305 x 305 mm	9 / 4.1	14 / 6.4

This Product Exceeds OSHA, ANSI and Other International Standards.

**TRANSPORTER™
FEATURES & BENEFITS**

- No positive airflow
- Fabric withstands decontamination with standard bleach solution to eliminate bloodborne pathogens and DNA cross-contamination.
- Cabinet includes plastic hangers, a plastic zipper designed for tamper-proof seals, hanging rod, push handle, locking wheels, evidence tray, and biological hazard warning label.



Transporter™

Special Purpose : Basic Evidence Transporter

- The Safekeeper Mobile Evidence Transporter is designed to maintain the integrity and credibility of evidence collected in the field, while permitting air drying prior to processing.
- Ships and stores knocked down for compact storage; can be quickly field-assembled as needed.
- White PVC frame with Texilene™ mesh fabric to conceal unsightly material from display, is resistant to liquids and odors, and is easily cleaned with conventional detergent.
- Evidence Transporter™ FDC-BASIC

MODEL	External (W x D x H)		Shipping (W x D x H)		WEIGHT (lbs/Kg)	
					Net	Ship
Evidence Transporter™						
FDC-BASIC	35" x 30" x 69" 889 x 672 x 1753 mm	30" x 30" x 13" 672 x 672 x 331 mm	34 / 16	38 / 18		

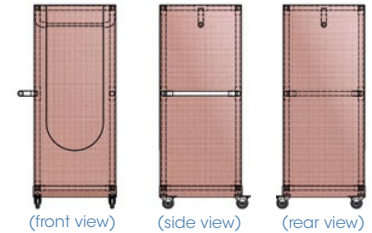

SAFEKEEPER® SERIES OPTIONS & ACCESSORIES

Option		Models	Part
Monitair® Controller*	Microprocessor controller to monitor cabinet operating parameters, airflow, containment, and filter condition; emits audio and visual alerts if conditions become unsafe.	General Purpose & Drugkeeper™	MON-P
Filter Saturation Alarm*	An electronic gas sensor emits audio and visual alerts when the main filter needs to be changed.	General Purpose & Drugkeeper™	FSA
Stainless Steel Leveling Feet	Adjustable leveling feet. (Included on XT models)	General Purpose & Drugkeeper™	LEVEL
Locking Wheels	Non-marking heavy duty caster wheels. (Included on Standard height and Downflow)	General Purpose Tall Units	WHEEL
Internal Fluorescent Lamp*	Lamp in vapor proof housing. (Included with Monitair® option)	All but Basic model	LAMP
DNA Decontamination UV Lamp**	A UV lamp is available for overnight decontamination of interior surfaces. The UV kit includes a timer and door micro switch interlock. The UV operation must comply with local codes and facility safety practices. Contact your facility safety officer for details.	All Units except Transporter	UV-XX
Windowless Doors	Used in locations near public viewing areas to conceal cabinet contents.	All Units	S-D
Evidence Drying and Collection Trays	Tray fits into bottom of cabinet for additional drying space and allows trace items to fall into it. Available in white or black.	General Purpose & Drugkeeper™	TRAY-BLACK, TRAY-WHITE
Blower Timer	Automatically turns blower off at preset time.	All units	BTIME
Ducting Collar	Allows unit to be connected to ductwork for run in vented mode, ductless mode, or both.	General Purpose & Drugkeeper™	DUCT-8
Automatic Wash Down System	Automatic wash down of cabinet interior. Includes chemical mixing tank to inject cleaning agents.	All upflow General Purpose models	EXCOL
Waste Water Container	Safekeeper cabinets have built-in contaminant containment compartments that adhere to Occupational Safety and Health Administration (OSHA) standards 29 CFR 1910.1030 regarding bloodborne pathogens.	General Purpose & Drugkeeper™	WWC
Start-Up Supply Kit	The start-up kit provides everything required to safely operate and maintain a forensic evidence cabinet. Includes hangers, latex gloves, disinfectant spray, paper lining for collecting trace evidence, tamper proof seals and a set of pre-filters.	General Purpose & Drugkeeper™	START KIT

* Factory installed; specify when ordering.

** Includes timer, and door micro switch. Safety precautions must be followed.

This Product Exceeds OSHA, ANSI and Other International Standards.



120 6th Street • Fort Myers, FL 33907
T/239.489.0024 • Toll Free/800.306.0656 • F/800.306.0677
www.airscience.com

